

# CONNETTORI CON CAVO COSTAMPATO

**mPm**

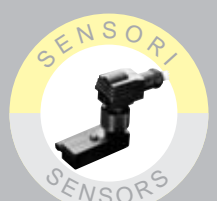

## MOULDED CABLE CONNECTORS

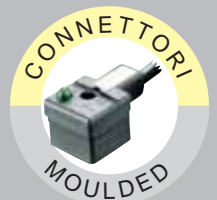
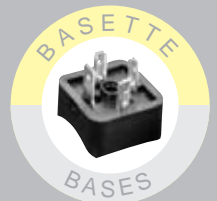
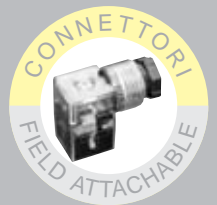

**W Woodhead**

The Global Leader in Industrial Communications and Connectivity

**Connettori con cavo costampato EN 175301-803 (ex DIN43650)**

I connettori con cavo costampato possono essere utilizzati in tutte le applicazioni nelle quali sia prevista una connessione elettrica tramite connettore su tutti i tipi di solenoidi. L'uso di tali connettori riduce notevolmente i tempi di installazione eliminando il cablaggio manuale. Sono disponibili in diverse versioni; con o senza circuito di visualizzazione e protezione e con varie tipologie e lunghezze di cavo. Nel caso della versione con circuito, il connettore viene fornito con schema elettrico stampato per una corretta identificazione.

**Pre-Wired solenoid connectors with moulded cables EN 175301-803 (ex DIN43650)**

Our connectors with moulded in cable are suitable for use with most types of solenoid. They offer a fast and efficient method of connection resulting in greatly reduced installation time and cost. They can be supplied with or without integral LED indicators and suppression circuits. A diagram is printed on each connector with circuit to allow for easy user identification.

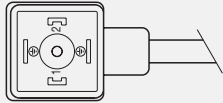
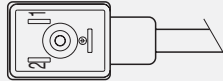
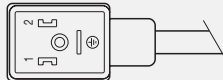
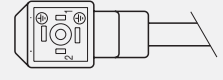
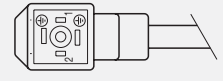
<b>Serie senza circuito</b> <i>Series without circuit</i>		<b>Serie con circuito</b> <i>Series with circuit</i>		
<b>Forma A /Form A (ISO 4400 - DIN 43650)</b>				
<b>E152-E153-E312-E313</b>		<b>E452-E453</b>		
Interasse dei contatti/ <i>Contact spacing 18 mm</i>				
<b>Forma industriale/Industrial form (Industriale-Industrial DIN 43650)</b>				
<b>E162-E322</b>		<b>E462</b>		
Interasse dei contatti/ <i>Contact spacing 11 mm</i>				
<b>Forma B rettangolare/Form B (ISO 6952-DIN 43650)</b>				
<b>E072-E082</b>		<b>E472</b>		
Interasse dei contatti/ <i>Contact spacing 10 mm</i>				
<b>Micro (15x15)</b>				
<b>E332-E333</b>		<b>E392</b>		
Interasse dei contatti/ <i>Contact spacing 9,4 mm</i>				
<b>Forma C/Form C (DIN 43650 15x15)</b>				
<b>E432-E433</b>		<b>E492</b>		
Interasse dei contatti/ <i>Contact spacing 8 mm</i>				



**Specifiche sui tipi di cavi / Cable types**

Tipo di cavo Cable type	Codice Code	Caratteristiche Features	N° conduttori Stranding	Raggio di curvatura Bending radius
PVC	N	Adatto ad applicazioni generiche con caratteristiche di buona resistenza all'acqua, ma scarsa resistenza all'olio. <i>Application general purpose cable which has good resistance to water, but usually poor oil resistance.</i>	0.5 mm <sup>2</sup> = 15 x 0.20 0.75 mm <sup>2</sup> = 21 x 0.20 1 mm <sup>2</sup> = 28 x 0.20	15 X Ø esterno 15 X outside Ø
CEI	I	Approvato IEC332 - 2A, non propagante alla fiamma e autoestinguente. Offre una limitata resistenza agli olii minerali. <i>Approved to IEC 332-2A, flame retardant and self extinguishing. Limited resistant to mineral oils.</i>	0.5 mm <sup>2</sup> = 28 x 0.15 0.75 mm <sup>2</sup> = 42 x 0.15 1 mm <sup>2</sup> = 32 x 0.20	10 X Ø esterno 10 X outside Ø
PUR	P	Offrono buona resistenza agli olii e agli agenti chimici. Può dilatarsi se immerso in acqua. <i>Offer good resistance to oil and chemicals. Can swell when constantly immersed in water.</i>	0.5 mm <sup>2</sup> = 28 x 0.15 0.75 mm <sup>2</sup> = 42 x 0.15 1 mm <sup>2</sup> = 32 x 0.20	10 X Ø esterno 10 X outside Ø
PVC CSA-UL	A	Approvato CSA-UL 2661, adatto ad applicazioni generiche con caratteristiche di buona resistenza all'acqua, ma scarsa resistenza all'olio. <i>Approved to CSA-UL 2661, application general purpose cable which has good resistance to water, but usually poor oil resistance.</i>	20 AWG = 32 x 0.15 18 AWG = 52 x 0.15	10 X Ø esterno 10 X outside Ø
PUR CSA-UL	B	Approvato CSA-UL 20668, offre una buona resistenza agli olii e agli agenti chimici. <i>Approved to CSA-UL 20668, very good resistance to oil and chemicals.</i>	20 AWG = 32 x 0.15 18 AWG = 52 x 0.15	10 X Ø esterno 10 X outside Ø

mPm code <input type="checkbox"/> <input type="checkbox"/>		Materiale Material	Colore Colour	N° Cond.	Sezione Section	Esterno Ø Ext Ø	Temp. range	DIN A-B	DIN C
I	2	PVC CEI 2022 II O.R.	Grigio/Grey RAL7035	2	0,5 mm <sup>2</sup>	5,5+/-0,2 mm	-5 +70	✓	✓
I	2	PVC CEI 2022 II O.R.	Grigio/Grey RAL7035	3	0,5 mm <sup>2</sup>	5,5+/-0,2 mm	-5 +70	✓	✓
I	2	PVC CEI 2022 II O.R.	Grigio/Grey RAL7035	4	0,5 mm <sup>2</sup>	6,5+/-0,2 mm	-5 +70	✓	
I	2	PVC CEI 2022 II O.R.	Grigio/Grey RAL7035	5	0,5 mm <sup>2</sup>	7+/-0,2 mm	-5 +70	✓	
P	2	PUR - BLEND	Nero/Black	2	0,5 mm <sup>2</sup>	5,5+/-0,2 mm	-5 +70	✓	✓
P	2	PUR - BLEND	Nero/Black	3	0,5 mm <sup>2</sup>	5,5+/-0,2 mm	-5 +70	✓	✓
P	2	PUR - BLEND	Nero/Black	5	0,5 mm <sup>2</sup>	7+/-0,2 mm	-5 +70	✓	✓
F	2	CNOMO	Grigio/Grey RAL7000	3	0,5 mm <sup>2</sup>	5,5+/-0,2 mm	-5 +70	✓	✓
A	2	PVC CSA/UL 2661	Nero/Black	2	20 AWG	5,5+/-0,2 mm	-15+105	✓	✓
A	2	PVC CSA/UL 2661	Nero/Black	3	20 AWG	5,6+/-0,2 mm	-15+105	✓	✓
A	2	PVC CSA/UL 2661	Nero/Black	4	20 AWG	6,2+/-0,2 mm	-15+105	✓	✓
A	2	PVC CSA/UL 2661	Nero/Black	5	20 AWG	7+/-0,2 mm	-15+105	✓	
A	7	PVC CSA/UL 2661	Giallo/Yellow	3	20 AWG	5,6+/-0,2 mm	-15+105	✓	✓
B	2	PUR CSA/UL 20668	Nero/Black	2	20 AWG	5,5+/-0,2 mm	-25+90	✓	✓
B	2	PUR CSA/UL 20668	Nero/Black	3	20 AWG	5,6+/-0,2 mm	-25+90	✓	✓
B	2	PUR CSA/UL 20668	Nero/Black	4	20 AWG	6,2+/-0,2 mm	-25+90	✓	✓
B	2	PUR CSA/UL 20668	Nero/Black	5	20 AWG	7+/-0,2 mm	-25+90	✓	
P	3	PUR - BLEND	Nero/Black	2	0,75 mm <sup>2</sup>	6,5+/-0,2 mm	-5 +70	✓	
P	3	PUR - BLEND	Nero/Black	3	0,75 mm <sup>2</sup>	6,5+/-0,2 mm	-5 +70	✓	
P	3	PUR - BLEND	Nero/Black	4	0,75 mm <sup>2</sup>	7+/-0,2 mm	-5 +70	✓	
A	3	PVC CSA/UL 2661	Nero/Black	2	18 AWG	6,5+/-0,2 mm	-15+105	✓	
A	3	PVC CSA/UL 2661	Nero/Black	3	18 AWG	6,5+/-0,2 mm	-15+105	✓	
A	3	PVC CSA/UL 2661	Nero/Black	4	18 AWG	7+/-0,2 mm	-15+105	✓	
A	3	PVC CSA/UL 2661	Nero/Black	5	18 AWG	7,8+/-0,2 mm	-15+105	✓	
B	3	PUR CSA/UL 20668	Nero/Black	2	18 AWG	6,5+/-0,2 mm	-25+90	✓	
B	3	PUR CSA/UL 20668	Nero/Black	3	18 AWG	6,5+/-0,2 mm	-25+90	✓	
B	3	PUR CSA/UL 20668	Nero/Black	4	18 AWG	7+/-0,2 mm	-25+90	✓	
B	3	PUR CSA/UL 20668	Nero/Black	5	18 AWG	7,8+/-0,2 mm	-25+90	✓	
I	4	PVC CEI 2022 II O.R.	Grigio/Grey RAL7035	2	1 mm <sup>2</sup>	7,1+0,2-0 mm	-5 +70	✓	
I	4	PVC CEI 2022 II O.R.	Grigio/Grey RAL7035	3	1 mm <sup>2</sup>	7,1+0,2-0 mm	-5 +70	✓	
F	4	CNOMO	Grigio/Grey RAL7000	4	1 mm <sup>2</sup>	7,1+0,2-0 mm	-5 +70	✓	
N	2	PVCH03	Nero/Black	2	0,5 mm <sup>2</sup>	5,1+ 0,2-0 mm	-5 +70	✓	✓
N	2	PVCH03	Nero/Black	3	0,5 mm <sup>2</sup>	5,4+ 0,2-0 mm	-5 +70	✓	✓
N	2	PVCH03	Nero/Black	4	0,5 mm <sup>2</sup>	5,75+0,2-0 mm	-5 +70	✓	✓
N	3	PVCH05	Nero/Black	2	0,75 mm <sup>2</sup>	6,2+ 0,2-0 mm	-5 +70	✓	
N	3	PVCH05	Nero/Black	3	0,75 mm <sup>2</sup>	6,6+0,2-0 mm	-5 +70	✓	
N	3	PVCH05	Nero/Black	4	0,75 mm <sup>2</sup>	7,15+0,2-0 mm	-5 +70	✓	
N	3	PVCH05	Nero/Black	5	0,75 mm <sup>2</sup>	8,0+0,2-0 mm	-5 +70	✓	
N	4	PVCH05	Nero/Black	2	1 mm <sup>2</sup>	6,5+0,2-0 mm	-5 +70	✓	
N	4	PVCH05	Nero/Black	3	1 mm <sup>2</sup>	6,9+0,2-0 mm	-5 +70	✓	
N	5	PVCH05	Nero/Black	3	1,5 mm <sup>2</sup>	8,3+0,2-0 mm	-5 +70	✓	

**E65**

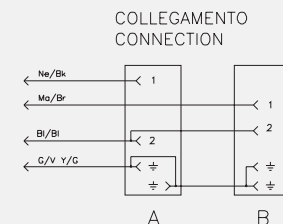
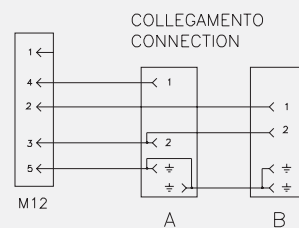
- Distanza contatti  
*Contact distance* 18 mm
  - Tensione nominale  
*Nominal Voltage*
    - AC max. 250 V
    - DC max. 300 V
  - Protezione  
*Housing* PP
  - Corrente max.  
*Max. current* 5A
  - Resistenza contatti  
*Contact resistance* ≤ 4 m Ohm
  - Grado di protezione  
*Protection class* IP 65 EN 60529
  - Classe isolamento  
*Insulation class* VDE 0110-1/89
  - Imballo  
*Packing unit* 100 pz. con vite di fissaggio e guarnizione NBR profilata
- 100 pcs. with fixing screw and NBR profiled gasket*



**Codici di ordinazione  
order codes**

**E 6 5 3 A 2 N A 2 6 1 1 C 4 H**

**Numero poli / Number of poles**

2= 2 poli + terra / 2 poles + earth; 3= 3 poli + terra / 3 poles + earth;  
A= M12 diritto/straight; B= M12 90°

**Tipo cavo / Cable type**

Consultare pagina / For cable options see pages: 47

**Sezione cavo / Cable cross section area**

Consultare pagina / For cable options see pages: 47

**Colore testa / Head colour**

G= Grigio/Grey; N= Nero/Black; T= Trasparente/Clear;  
A= CSA - UL Nero/Black; B= CSA - UL Grigio/Grey

**Lunghezza cavo principale in metri / Cable Length**

A= 1; B= 1,5; C= 2; D= 2,5; E= 3; F= 3,5; G= 4; H= 4,5; L= 5;  
M= 5,5; N= 6; P= 6,5; Q= 7; R= 7,5; S= 8; T= 8,5; U= 9; K= 10  
0= M12 costampato sulla testa Din / moulded on the Din head

**Distanza tra le due teste / Distance between the two heads**

Distanza tra le due teste espressa in cm / Distance between the two head in cm  
esempio / example 130 mm= 13 (minima distanza possibile / minimum possible distance 130 mm)

**Posizione terra / Earth pin location**

1= H6; 2= H12

**Guarnizioni-viti /Gasket-screws:**

- 1= Guarnizione a profilo in NBR + vite di fissaggio / NBR profile gasket + fixing screw
- 2= Guarnizione piana in NBR + vite di fissaggio / NBR flat gasket + fixing screw
- 3= Guarnizione a profilo in silicone + vite di fissaggio / Silicon profile gasket + fixing screw
- 4= Guarnizione piana in silicone + vite di fissaggio / Silicon flat gasket + fixing screw

**Tipo di circuito / Internal circuit**

Consultare pagina / For circuit options see pages: 20

**Tensioni e colori LED/Supply voltage and LED colour:**

1= 12V	} LED rosso o lampada* Red LED or lamp*	A= 12V	} LED verde Green LED	G = 12V	} LED giallo Amber LED
2= 24V		B= 24V		H = 24V	
3= 48V		C= 48V		K = 48V	
4= 115V		D= 115V		L = 115V	
5= 230V		E= 230V		M = 230V	

Cavi liberi  
Flying lead

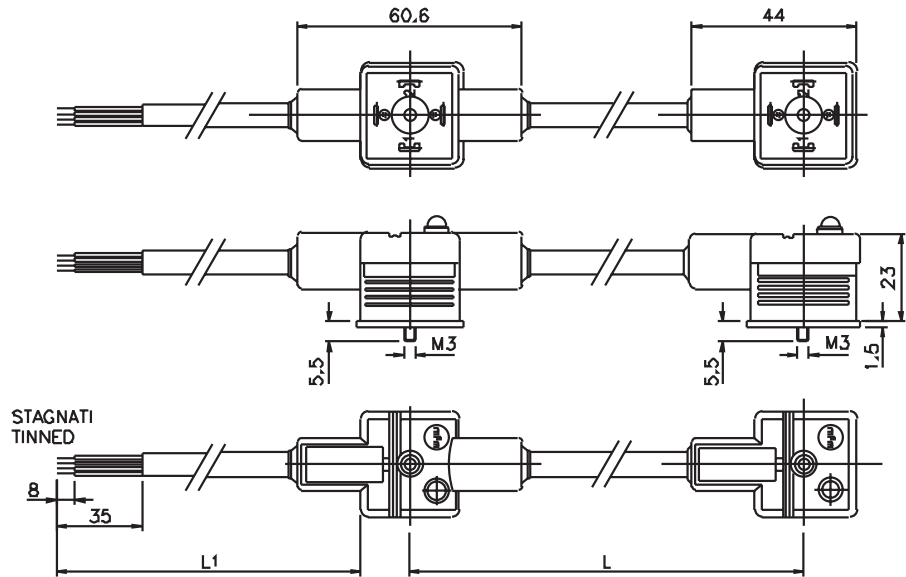

Connettore M12  
M12 straight connector

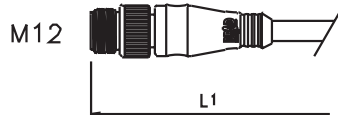

Connettore M12 90°  
M12 90° connector

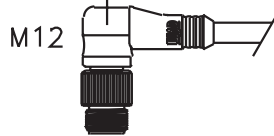

Connettore M12  
costampato  
nel connettore DIN  
M12 connector  
over moulded  
on DIN connector

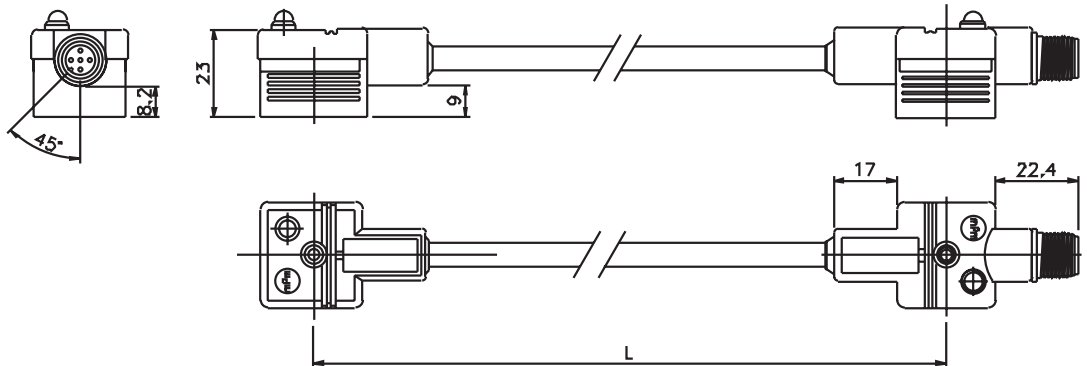

Connettore M12 90°  
costampato nel connettore DIN  
M12 90° connector  
over moulded  
on DIN connector

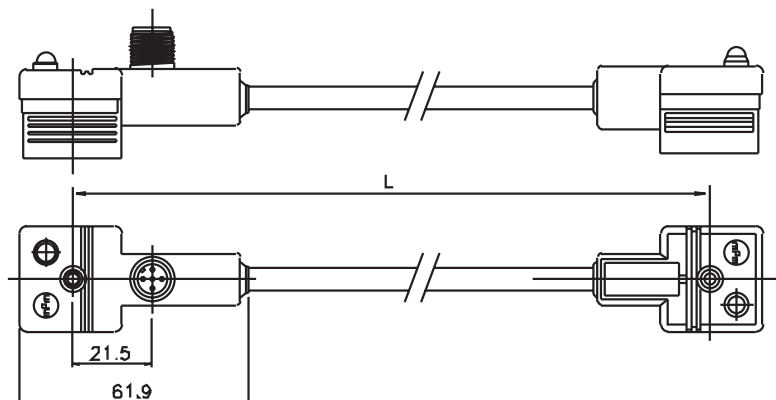



**E66**

- Distanza contatti  
*Contact distance* 11 mm
  - Tensione nominale  
*Nominal Voltage*
    - AC max. 250 V
    - DC max. 300 V
  - Protezione  
*Housing* PP
  - Corrente max.  
*Max. current* 5A
  - Resistenza contatti  
*Contact resistance* ≤ 4 m Ohm
  - Grado di protezione  
*Protection class* IP 65 EN 60529
  - Classe isolamento  
*Insulation class* VDE 0110-1/89
  - Imballo  
100 pz. con vite di fissaggio e guarnizione NBR profilata
- Packing unit* 100 pcs. with fixing screw and NBR profiled gasket

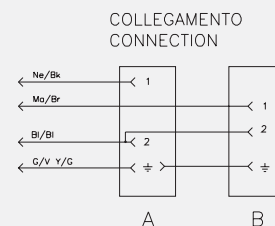
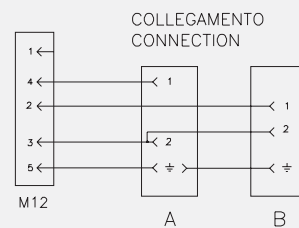

**Codici di ordinazione order codes**

**E 6 6 2 A 2 N A 2 6 1 1 C 4 H**

**Numero poli / Number of poles**

2= 2 poli + terra / 2 poles + earth; 3= 3 poli + terra / 3 poles + earth;  
A= M12 dritto/straight; B= M12 90°

**Tipo cavo / Cable type**

Consultare pagina / For cable options see pages: 47

**Sezione cavo / Cable cross section area**

Consultare pagina / For cable options see pages: 47

**Colore testa / Head colour**

G= Grigio/Grey; N= Nero/Black; T= Trasparente/Clear;  
A= CSA - UL Nero/Black; B= CSA - UL Grigio/Grey

**Lunghezza cavo principale in metri / Cable Length**

A= 1; B= 1,5; C= 2; D= 2,5; E= 3; F= 3,5; G= 4; H= 4,5; L= 5;  
M= 5,5; N= 6; P= 6,5; Q= 7; R= 7,5; S= 8; T= 8,5; U= 9; K= 10  
0= M12 costampato sulla testa Din / moulded on the Din head

**Distanza tra le due teste / Distance between the two heads**

Distanza tra le due teste espressa in cm / Distance between the two head in cm  
esempio / example 130 mm= 13 (minima distanza possibile / minimum possible distance 130 mm)

**Posizione terra / Earth pin location**

1= H6; 2= H12

**Guarnizioni-viti /Gasket-screws:**

- 1= Guarnizione a profilo in NBR + vite di fissaggio / NBR profile gasket + fixing screw
- 2= Guarnizione piana in NBR + vite di fissaggio / NBR flat gasket + fixing screw
- 3= Guarnizione a profilo in silicone + vite di fissaggio / Silicon profile gasket + fixing screw
- 4= Guarnizione piana in silicone + vite di fissaggio / Silicon flat gasket + fixing screw

**Tipo di circuito / Internal circuit**

Consultare pagina / For circuit options see pages: 86

**Tensioni e colori LED/Supply voltage and LED colour:**

1= 12V	} LED rosso o lampada* Red LED or lamp*	A= 12V	} LED verde Green LED	G = 12V	} LED giallo Amber LED
2= 24V		B= 24V		H = 24V	
3= 48V		C= 48V		K = 48V	
4= 115V		D= 115V		L = 115V	
5= 230V		E= 230V		M = 230V	

Cavi liberi  
Flying lead

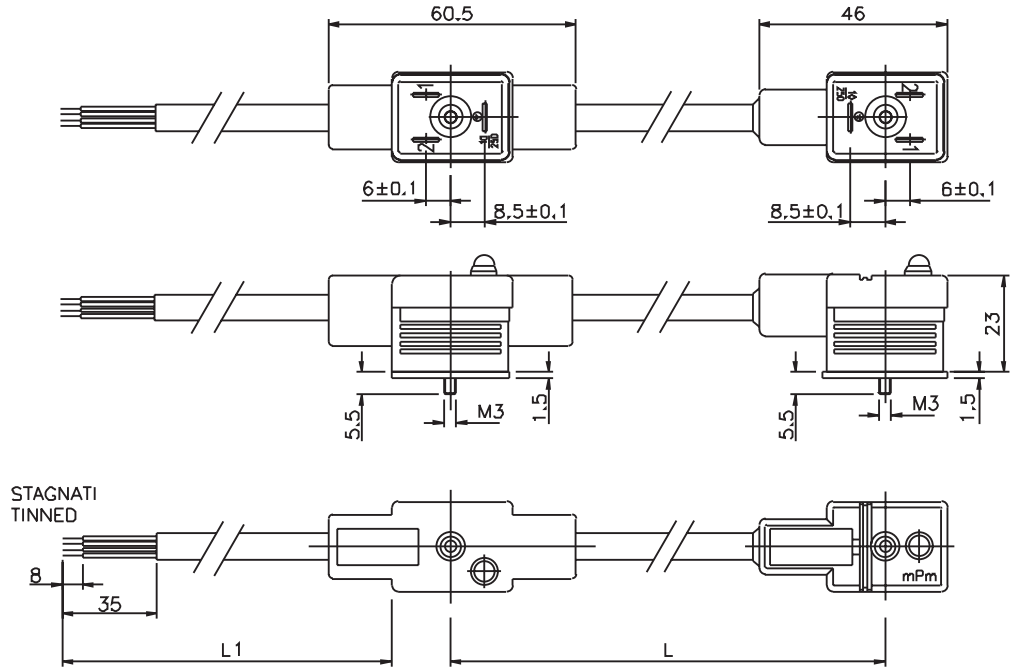

Connettore M12  
M12 straight connector

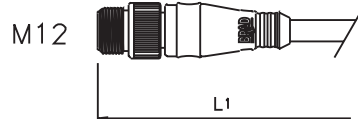

Connettore M12 90°  
M12 90° connector

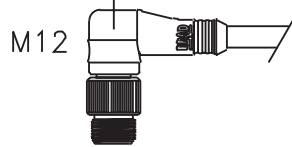

**E67**

- Distanza contatti  
*Contact distance* 10 mm
- Tensione nominale  
*Nominal Voltage*  
- AC max. 250 V  
- DC max. 300 V
- Protezione  
*Housing* PP
- Corrente max.  
*Max. current* 5A
- Resistenza contatti  
*Contact resistance* ≤ 4 m Ohm
- Grado di protezione  
*Protection class* IP 65 EN 60529
- Classe isolamento  
*Insulation class* VDE 0110-1/89
- Imballo  
*Packing unit* 100 pzs. con vite di fissaggio e guarnizione NBR profilata  
*100 pcs. with fixing screw and NBR profiled gasket*

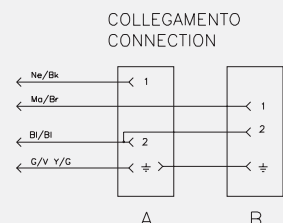
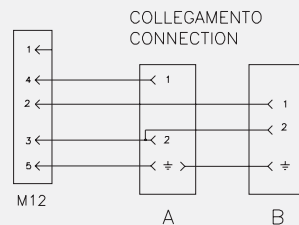

**Codici di ordinazione  
order codes**

**E 6 7 2 A 2 N A 2 6 1 1 C 4 H**

**Numero poli / Number of poles**

2= 2 poli + terra / 2 poles + earth; 3= 3 poli + terra / 3 poles + earth;  
A= M12 dritto/straight; B= M12 90°

**Tipo cavo / Cable type**

Consultare pagina / For cable options see pages: 47

**Sezione cavo / Cable cross section area**

Consultare pagina / For cable options see pages: 47

**Colore testa / Head colour**

G= Grigio/Grey; N= Nero/Black; T= Trasparente/Clear;  
A= CSA - UL Nero/Black; B= CSA - UL Grigio/Grey

**Lunghezza cavo principale in metri / Cable Length**

A= 1; B= 1,5; C= 2; D= 2,5; E= 3; F= 3,5; G= 4; H= 4,5; L= 5;  
M= 5,5; N= 6; P= 6,5; Q= 7; R= 7,5; S= 8; T= 8,5; U= 9; K= 10  
0= M12 costampato sulla testa Din / moulded on the Din head

**Distanza tra le due teste / Distance between the two heads**

Distanza tra le due teste espressa in cm / Distance between the two head in cm  
esempio / example 130 mm= 13 (minima distanza possibile / minimum possible distance 130 mm)

**Posizione terra / Earth pin location**

1= H6; 2= H12

**Guarnizioni-viti /Gasket-screws:**

- 1= Guarnizione a profilo in NBR + vite di fissaggio / NBR profile gasket + fixing screw
- 2= Guarnizione piana in NBR + vite di fissaggio / NBR flat gasket + fixing screw
- 3= Guarnizione a profilo in silicone + vite di fissaggio / Silicon profile gasket + fixing screw
- 4= Guarnizione piana in silicone + vite di fissaggio / Silicon flat gasket + fixing screw

**Tipo di circuito / Internal circuit**

Consultare pagina / For circuit options see pages: 86

**Tensioni e colori LED/Supply voltage and LED colour:**

1= 12V	} LED rosso o lampada* Red LED or lamp*	A= 12V	} LED verde Green LED	G = 12V	} LED giallo Amber LED
2= 24V		B= 24V		H = 24V	
3= 48V		C= 48V		K = 48V	
4= 115V		D= 115V		L = 115V	
5= 230V		E= 230V		M = 230V	



Cavi liberi  
Flying lead

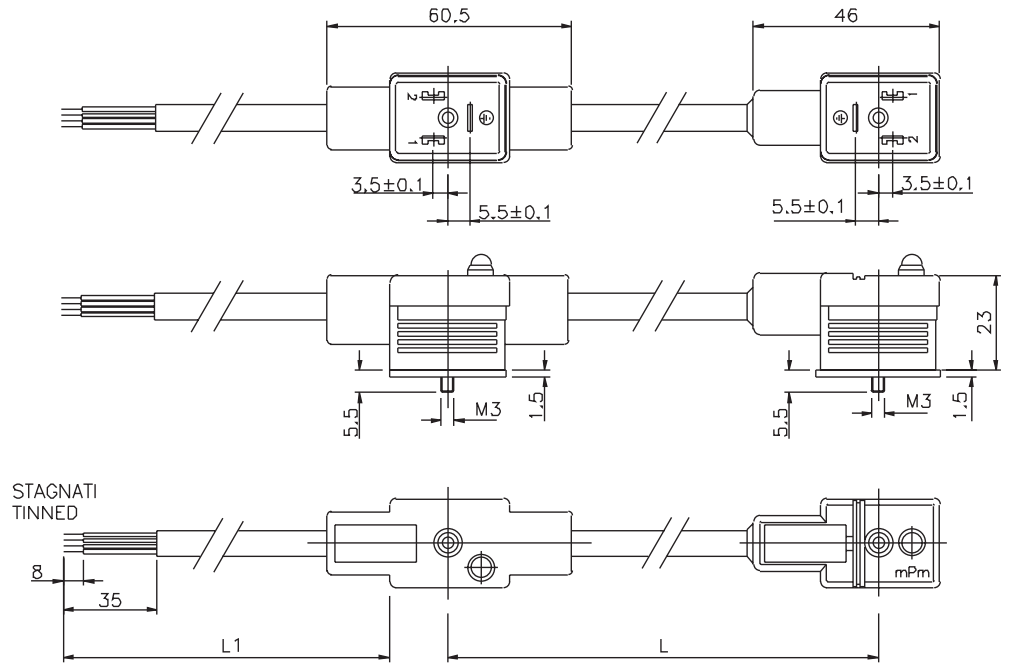

Connettore M12  
M12 straight connector

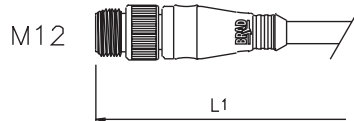

Connettore M12 90°  
M12 90° connector

